

NBS Specification

L10 - Windows / Rooflights / Screens / Louvres

460 - Rooflights

Manufacturer : Whitesales Europa House Alfold Road Cranleigh GU6 8NQ

Tel 01483 271371 Fax 01483 271771 E-mail sales@whitesales.co.uk

Product Reference : Em-View

Type : Flat glaze

Size : Specify from Product literature

Frame : Screwbolt - High security

Kerb : Em-Curb PVCu 150. Height 150mm

Material : PVCu - white self finish

Glazing details : Double glazed 4mm toughened clear outer,

15mm Argon filled cavity, 6.6mm laminated clear inner unit /

Polycarbonate single skin dome

Finish : Specify from Product literature

Other requirements : None

Fixing : Please consult Whitesales for recommendations

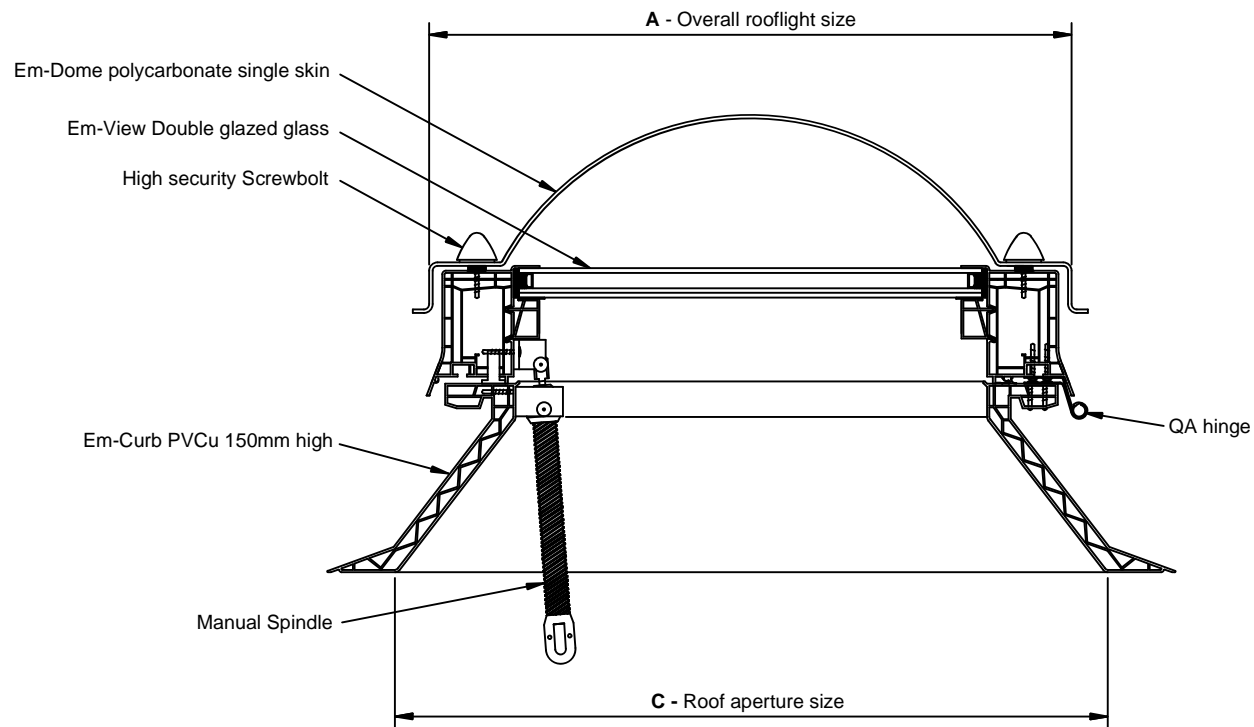

WHITESALES

DRG No 5001

Em-View double glazed unit rooflight complete with
Em-Dome polycarbonate single skin rooflight and
Em-Curb PVCu 150mm high